

	Technical Letter of Information
	Caution Vorsicht Varning
	SRS Airbag, Sensor etc.
	Plastic Plastik Plast
	Sound Insulation Schalldämpfendes material Ljuddämpningsmaterial

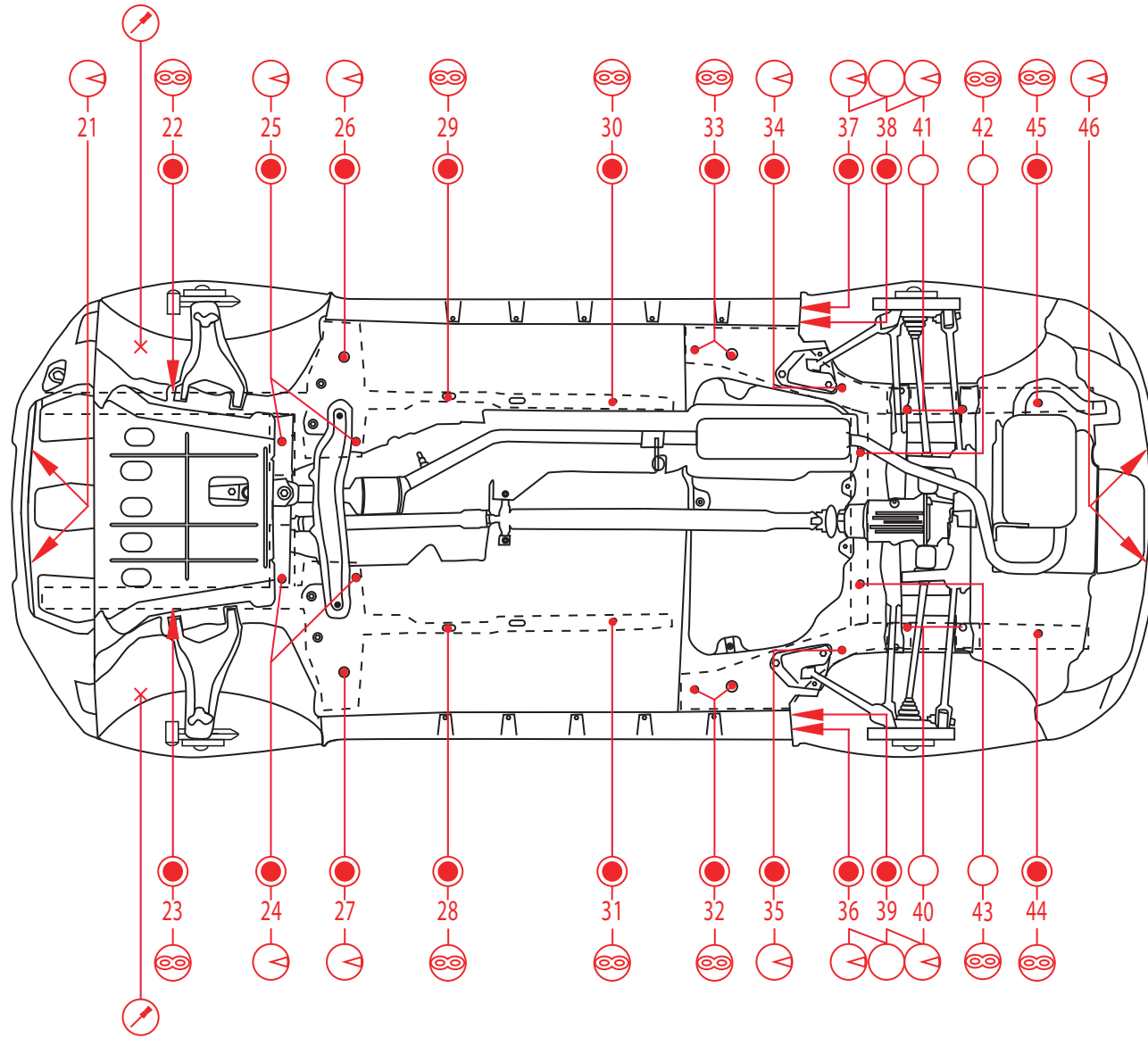

	Technical Letter of Information	
	Caution Vorsicht Varning	
	SRS Airbag, Sensor etc.	
	Plastic Plastik Plast	
	Sound Insulation Schalldämpfendes material Ljuddämpningsmaterial	

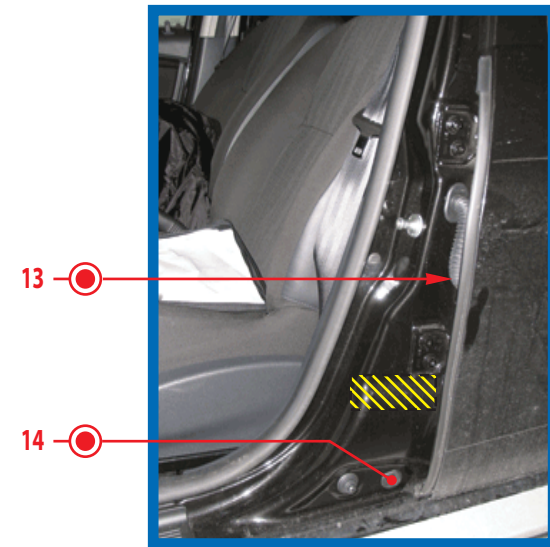
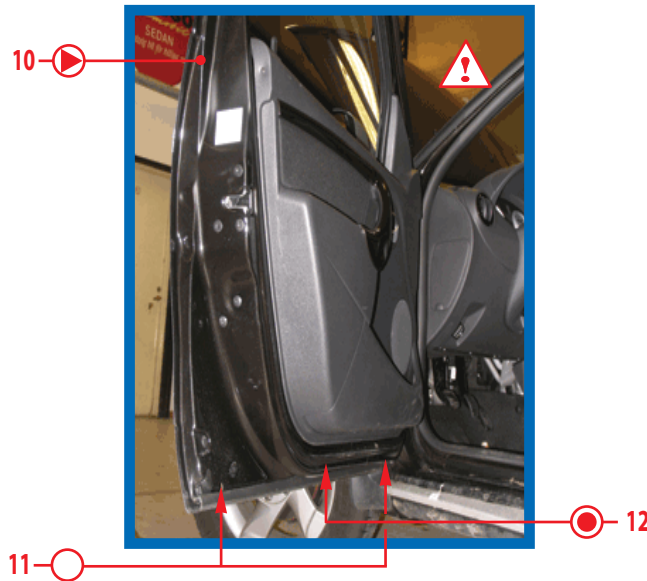
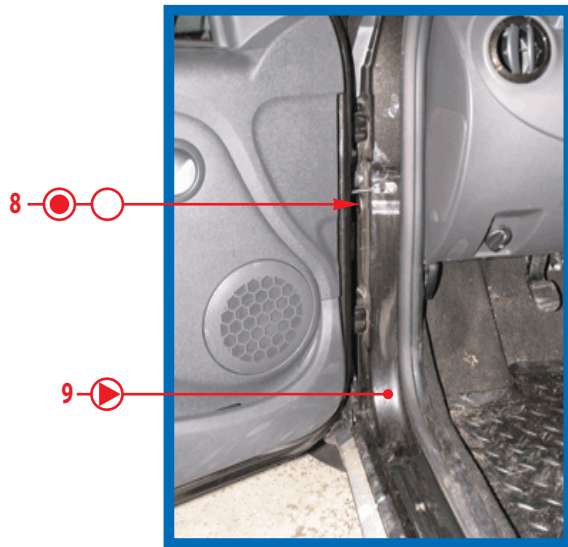
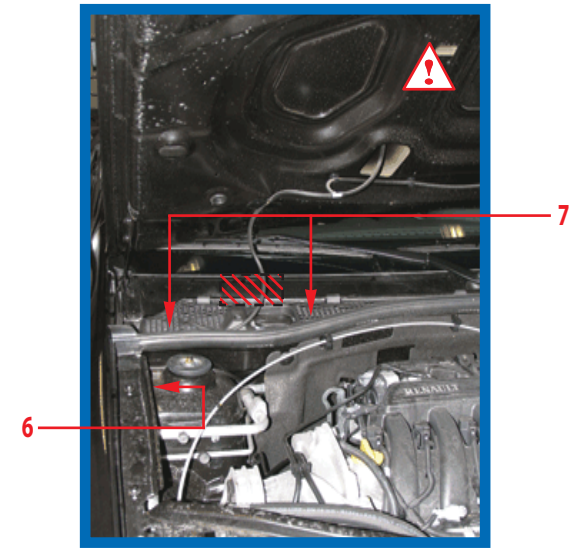
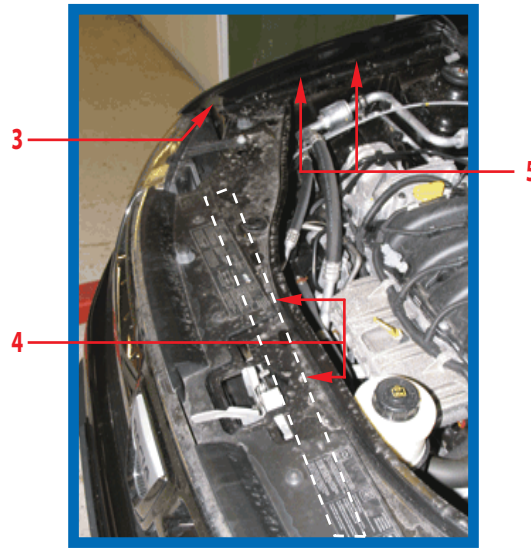
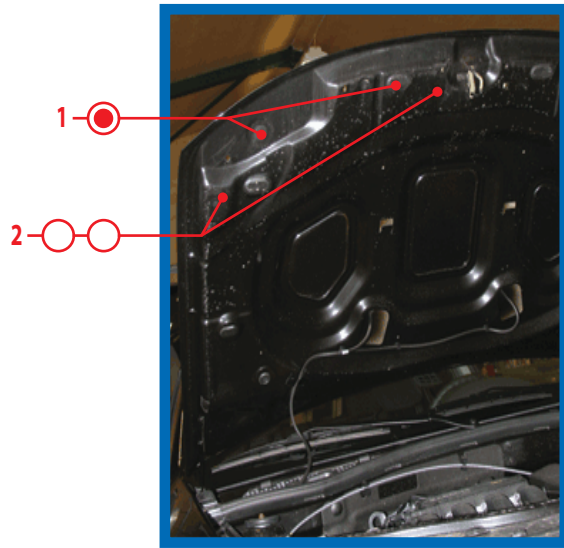

Caution Vorsicht Warning  
 Due to problems with seatbelts after treatment You have to be very careful when spraying B-pillars, above rear wheel arches or other places where the seatbelts are placed. The product should under no circumstance come in contact with the seatbelt mechanism as this can cause malfunction. Spray only under the Seatbelt mechanism and the SRS-Sensor



